

PLAN

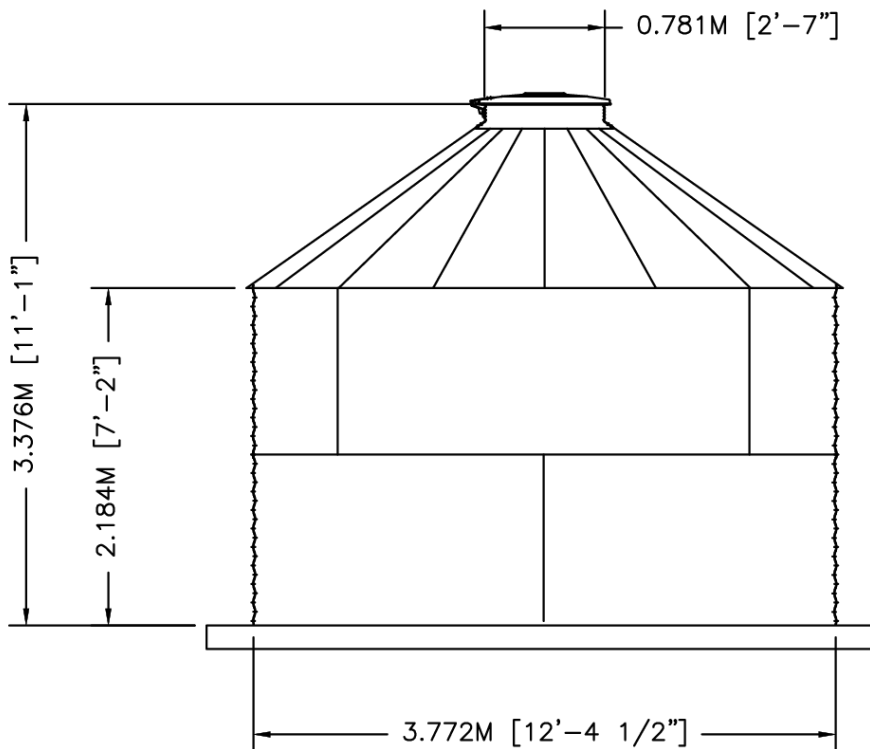

ELEVATION



	BY	DATE	TITLE	
DWN	XXX	XX/XX/XX	WTU04-02 30"PR 30DEG V-RIB	
CKD			NOMINAL CAPACITY - 22.985 M3 [6,072 GAL]	
ENG			DWG. NO. SCT1202-VR WTU04-02	REV. NO.
	SIZE: A	SCALE: 1/4"=1'-0"	SHEET 1	OF 1